

Pedestal

Function

The pedestals provide adjustable height support for all your decking and flooring requirements. For use on terraces, pool side, walkways, roofing and fountains.

The pedestals are available in heights from 35 mm - 1020 mm with a high load resistance of 800 kg each. The pedestal height can be increased or decreased by adding or removing supports or by rotating it's adjustment ring nut. Each support has a threaded base for a more precise adjustment.

Benefits:

- Simple and fast installation
- Perfect level adjustment
- Easy maintenance
- Allows access for passage of systems underneath the flooring.



Specifications

Materials

Polypropylene

Accessories

- Removable head with optional flooring spacing from 2.2 - 10mm.
- Add on levellers and slope correctors for uneven floor surface. Available from 1 % - 3 %. each leveller simply clips onto the base of the pedestal without the need of screws or clamps. Multiple levellers can be used on the same pedestal if required.

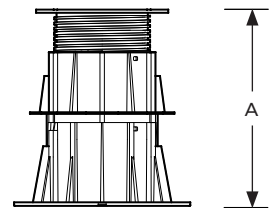
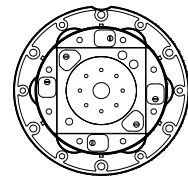

Model No.	A Height (mm)	No. of Extension required
240-617-001-035	35 - 50	-
240-617-001-050	50 - 75	-
240-617-001-075	75 - 120	-
240-617-002-121	121 - 211	-
240-617-002-211	211-301	1
240-617-002-301	301-391	2
240-617-002-391	391-481	3
240-617-002-481	481-571	4
240-617-002-571	571-661	5
240-617-002-661	661-751	6
240-617-002-751	751-841	7
240-617-002-841	841-931	8
240-617-002-931	931-1021	9

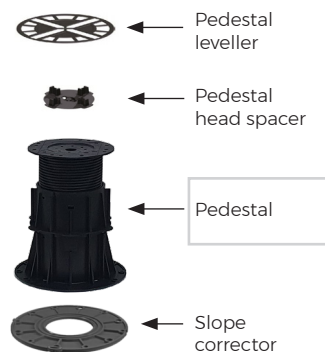

Pedestal	Pedestal Series	Model No. 240-617	Rev. 2	
<p>The information contained in this drawing is the sole property of Aquashi. Any reproduction in part or as a whole without the written permission of Aquashi is prohibited. Aquashi reserves the right to update all designs, specifications and data sheets without prior notice.</p>				

Pedestal

Pedestal Assembly Parts:

240-617-001-035



240-617-001-050

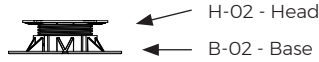

240-617-001-075

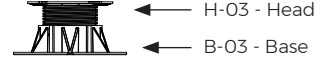

240-617-002-121

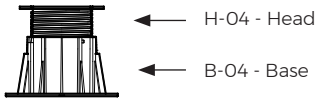

240-617-002-211

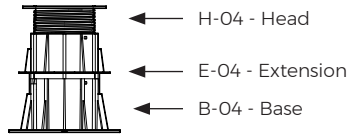

240-617-002-301

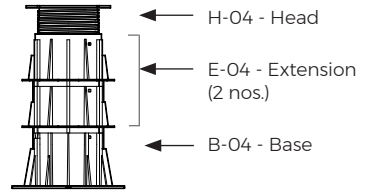

240-617-002-391

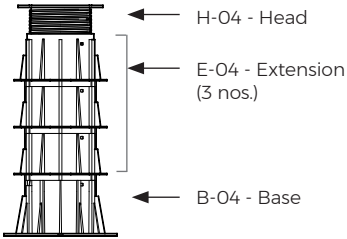

240-617-002-481

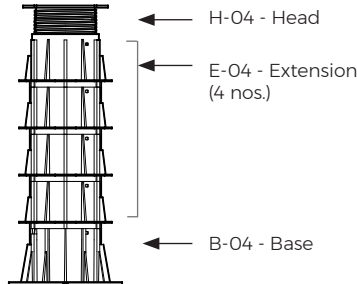

240-617-002-571

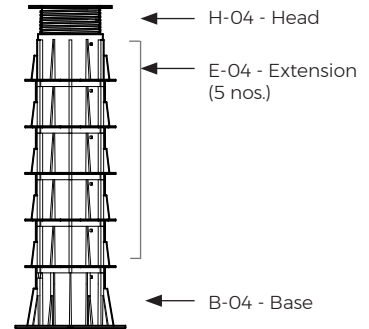

240-617-002-661

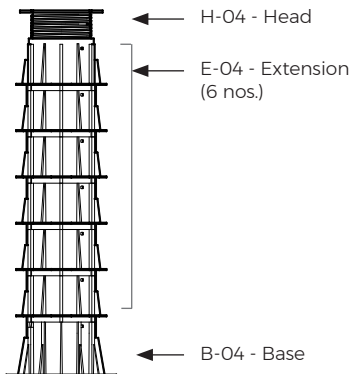

240-617-002-751

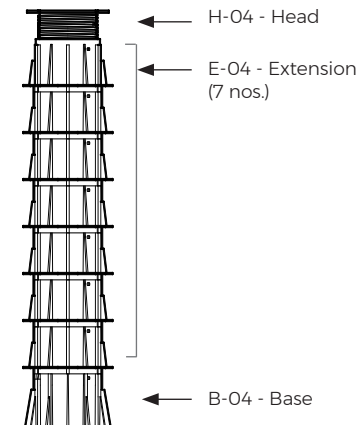

240-617-002-841

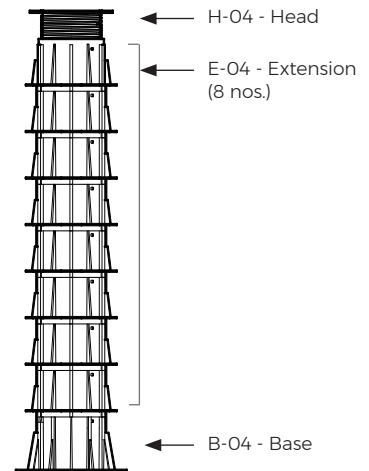

Pedestal	Pedestal Series	Model No. 240-617	Rev. 2	
<p>The information contained in this drawing is the sole property of Aquashi. Any reproduction in part or as a whole without the written permission of Aquashi is prohibited. Aquashi reserves the right to update all designs, specifications and data sheets without prior notice.</p>				

Pedestal

Spare Parts :



Pedestal Head - type 1
* H-01



Pedestal Base - type 1
* B-01



Pedestal Head - type 2
* H-02



Pedestal Base - type 2
* B-02



Pedestal Head - type 3
* H-03



Pedestal Base - type 3
* B-03



Pedestal Head - type 4
* H-04

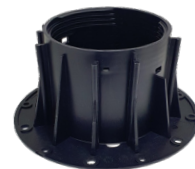

Pedestal Base - type 4
* B-04



Pedestal Extension - type 4
* E-04

Pedestal	Pedestal Series	Model No. 240-617	Rev. 2	
<p>The information contained in this drawing is the sole property of Aquashi. Any reproduction in part or as a whole without the written permission of Aquashi is prohibited. Aquashi reserves the right to update all designs, specifications and data sheets without prior notice.</p>				