

Water Level Controller - WLC-1000

Function

WLC-1000 is a conductive water level controller used in conjunction with 24VDC solenoid fill valve and water level float sensors or electrodes to monitor water levels in a fountain or pool. It can monitor up to three water level operations depending on the model selected.

WLC-1000 is compatible with WLS, WLE & FLS series water level sensors and electrodes.

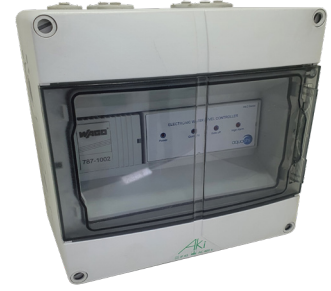

Specifications

Enclosure Material

Polycarbonate

Supply Voltage

110 - 230 VAC (50-60HZ)

Output Voltage

Quick fill Output Voltage: 24V DC

Safe off signal Output: Volt free contact

High alarm signal Output: Volt free contact

Protection Rating

IP 65

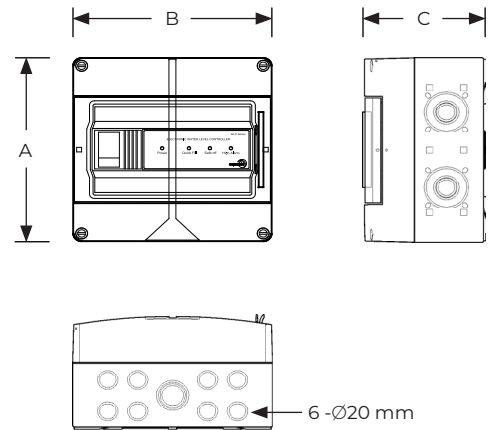

Model No.	No. of Sensors	Sensor Controls	Sensing Application	A (mm)	B (mm)	C (mm)
WLC-1000-H	3	High-Alarm + Quick fill + Safe-off	Hi-Alarm	198	198	120
WLC-1000-D	3	Quick fill on + Quick fill off + Safe-off	Differential	198	198	120

Note:

- Safe-off operation shuts off all in-pool electrical functions during low level conditions.
- Quick fill operation triggers fresh water supply valve to replenish the water loss in the pool.
- Hi-Alarm operation shuts down all in-pool electrical functions until high water level is resolved.

** Check installation manual for a more detailed explanation.

Mounting hole measurement

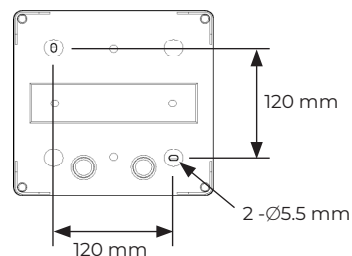

Water Level Controller	WLC-1000	Model No. WLC	Rev. 1	
<p>The information contained in this drawing is the sole property of Aquashi. Any reproduction in part or as a whole without the written permission of Aquashi is prohibited. Aquashi reserves the right to update all designs, specifications and data sheets without prior notice.</p>				

Water Level Controller - WLC-1000

WLC sample Float sensor usage:

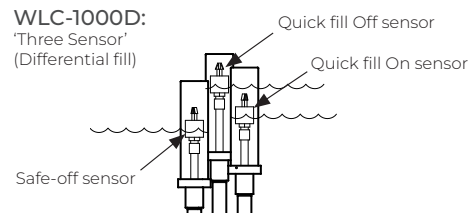
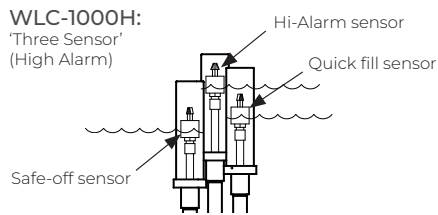

WLC sample Electrode sensor usage:

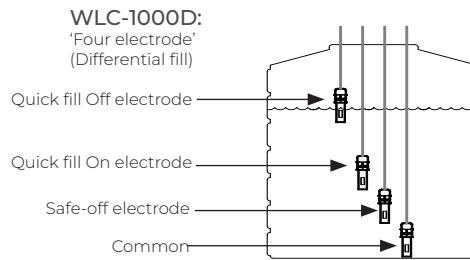
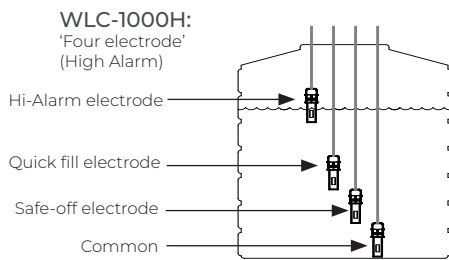

Accessories (Sold Separately)



Water Level Electrode
* WLE-1



Water Level Sensor Electrode
* WLE-300



Water Level Sensor - Compact
* WLS-C-100 (single sensor)



Water Level Sensor Electrode
* WLS-E-300



Floor Water Level Sensor
* FLS-M-300 (move type, three sensor)
* FLS-F-300 (fix type, three sensor)



Solenoid Fill Valve - Brass
* SVB-100DC (1" connection)
* SVB-150DC (1-1/2" connection)
* SVB-200DC (2" connection)

Water Level Controller	WLC-1000	Model No. WLC	Rev. 1	
<p>The information contained in this drawing is the sole property of Aquashi. Any reproduction in part or as a whole without the written permission of Aquashi is prohibited. Aquashi reserves the right to update all designs, specifications and data sheets without prior notice.</p>				